

MOUNTING GRAPHIC

(P.1)

1. Attach the top of the graphic onto the panel strip by removing each time a few inches of the protective liner of the tape.

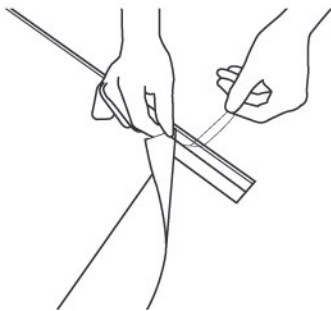

2. Align the graphic with the strip and press the graphic firmly on the strip.

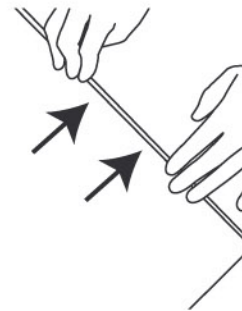

3. Repeat the above steps at the back of the graphic with security tape. Press firmly.

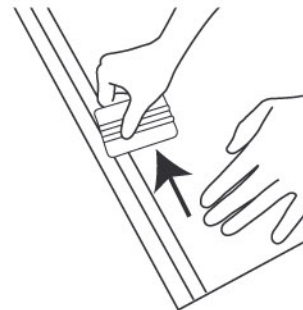
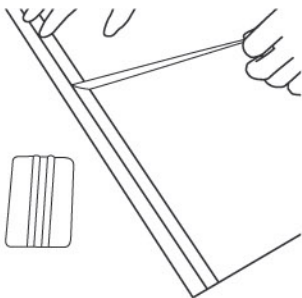

4. Slide the graphic into the top profile and secure with a piece of tape.

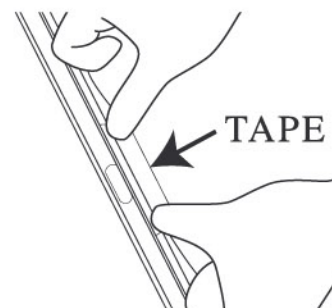
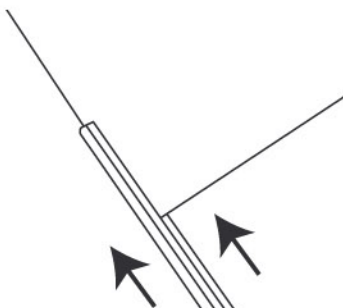

MOUNTING GRAPHIC

(P.2)

5. Attach the bottom of the graphic by aligning it with the adhesive tape on the white PVC.

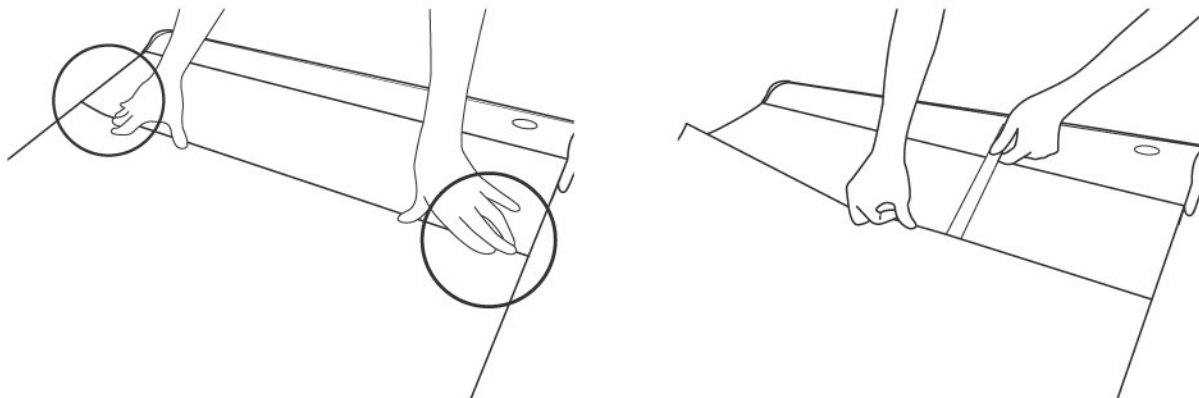

6. Press the graphic firmly and apply extra tape for reinforcement.

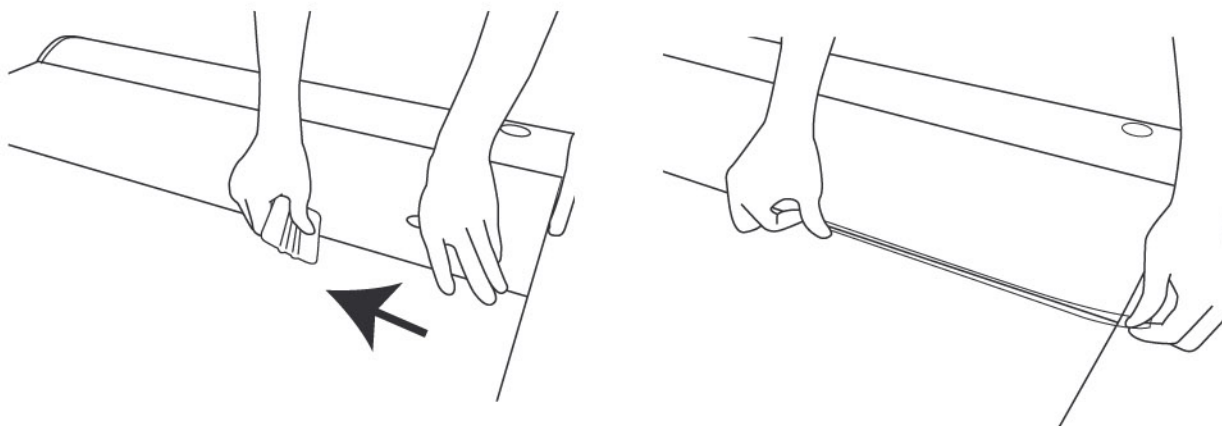

7. Hold the graphic while removing the key. Let the graphic retract into the base slowly.

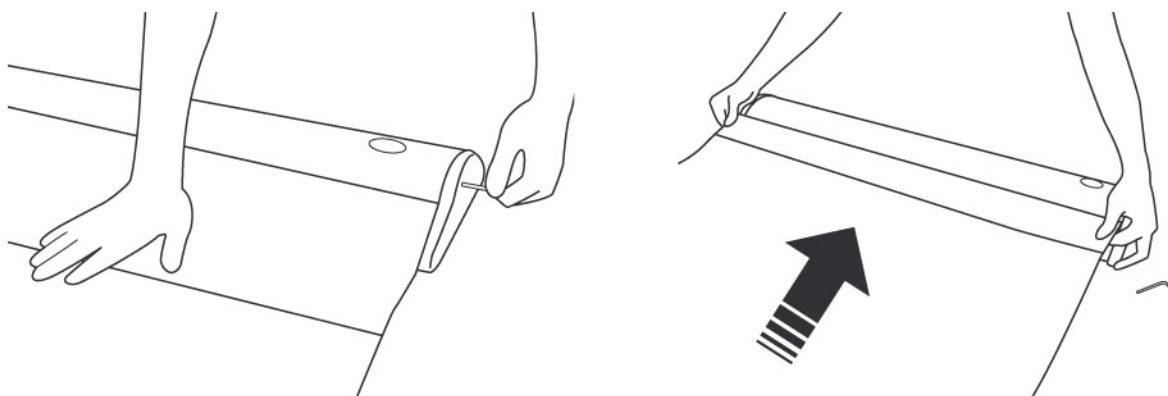

SET UP INSTRUCTION

3 - Parted Pole

1. Turn out the feet of the base.

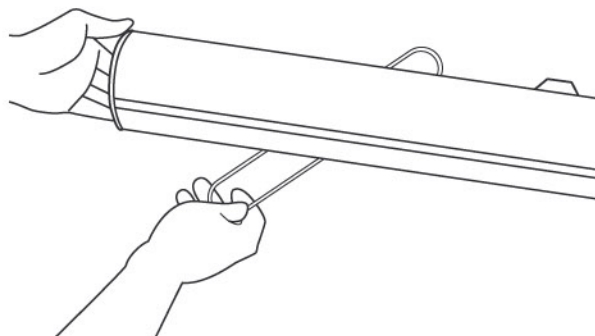
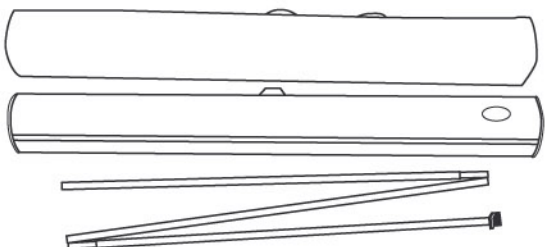

2. Unfold the 3-parted pole.

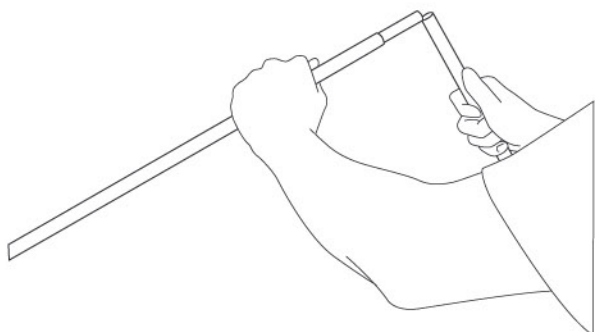

3. Pull up the graphic and position the plastic end tip of the pole into the top profile.

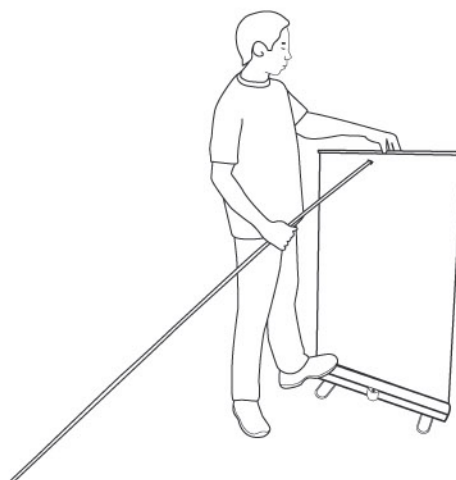

4. Insert the pole onto the cup of the base.

